



Towbar Fitting Instructions
To Suit **HOLDEN VF COMMODORE WAGON 2013 ON**
Part Number **HD96L**
Rating **1200/120 kg**

PLACE THESE INSTRUCTIONS IN THE VEHICLE'S GLOVEBOX AFTER INSTALLATION IS COMPLETED

WARNING:

1. Do not, drill, cut, weld or otherwise modify the tow bar.
2. If you are using electric welding on a motor vehicle, **always** check that the vehicle is not equipped with electronic engine or instrument management equipment. Failure to do so could **destroy** any onboard computers. If in doubt, check with the vehicle's manufacturer.
3. The high tensile fasteners supplied with this product were used to achieve the specified rating. If replacement is required ensure that fasteners of the same rating & quality are used. Contact an authorised **Trailboss** dealer if further information is required.

General:

1. Ensure all hardware items have been included refer to assembly diagram.
2. It is recommended that the instructions are read through and completely understood before making any attempt to fit this product.
3. Be wary of any changes to vehicle designs or other accessories that may conflict with the installation of this product.
4. Before drilling ensure that the area is clear of fuel, electrical & other components.
5. All holes drilled into the body panels shall have all burrs & swarf removed then coated with a suitable rust preventative paint.
6. For vehicles that require the bumper to be cut. Ensure cut out area is in correct position on the vehicle prior to cutting the bumper.
7. The high tensile fasteners supplied with this product were used to achieve the specified rating. If replacement is required ensure that fasteners of the same rating & quality are used. Contact an authorized **Trailboss** dealer if further information is required.
8. Ensure that all hardware is fastened to torque list below check fasteners on regular basis.
9. Tow bar load rating sticker provided with this product shall be conspicuously located on inside rear end of the driver's door. **(See diagram below)**.
10. Trailboss recommends that you check your tow ball to ensure that it complies with the Australian standards **AS 4177.2**.
11. **PLEASE NOTE:** It is advised to remove your lug or tbm when not actually towing so as to produce a clear view of the vehicles registration plate if obscured, and to also provide maximum available departure angle
12. Pull Pin must be fit in down position.

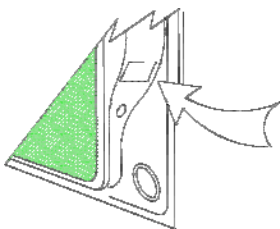

Place load rating sticker
inside driver's door here

FOR TRAILER TOWING PURPOSES ONLY
For towing capacity details please refer to vehicle owner's manual or to the manufacturer. Overloading can void your warranties.

RECOMMENDED ASSEMBLY TORQUE LISTING

Diameter	Grade 8.8 Bolt
M6	9.5 Nm
M8	21.7 Nm
M10	43.4 Nm
M12	77.3Nm
M14	146 Nm
M16	189.8 Nm

Tow bar Maintenance and Care.

Trailboss recommends that bolt torque's, as listed below, are routinely and regularly inspected and checked for correct tension. Replace any worn or defective parts.

We recommended to remove Tow Ball Mounts (TBM's, tongues or lugs) when not being used for any considerable length of time.

So as to avoid injury, when not towing it is suggested that the tongue, Pull Pin and R-clip are removed then stored in a safe, clean and dry place, away from excessive moisture.

Hitch Pull Pins and spring "R" clips are regularly checked for proper installation. Replace any worn or defective parts.



Towbar Fitting Instructions
 To Suit **HOLDEN VF COMMODORE WAGON 2013 ON**
 Part Number **HD96L**
 Rating **1200/120 kg**

PLACE THESE INSTRUCTIONS IN THE VEHICLE'S GLOVEBOX AFTER INSTALLATION IS COMPLETED

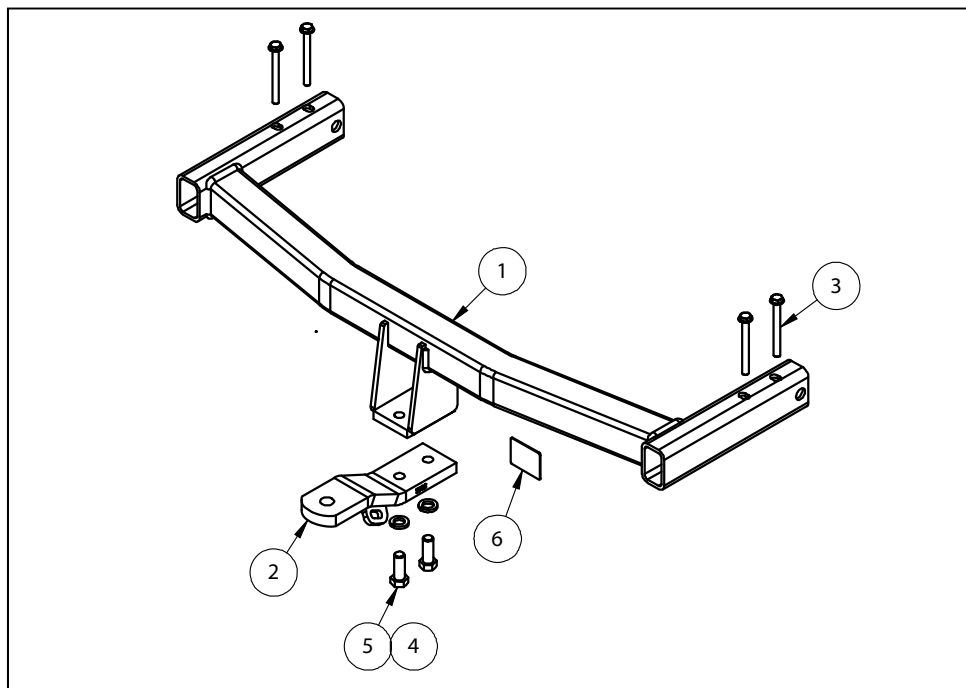

QTY	DESCRIPTION	ITEM NO
1	WELDED ASSEMBLY	1
1	ASSEMBLY LUG	2
4	M10x105x1.5P BOLT	3
2	M16 SPRING WASHER	4
2	M16x45x2.0P BOLT	5
1	ACRYLIC COMPLIANCE PLATE	6

ADDITIONAL ITEMS



 WIRING LOOM

 FITTING INSTRUCTION

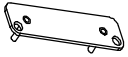
 LR LABEL

 PLUG BRACKET

 NUT NYLOC

 BUMPER TRIM



Towbar Fitting Instructions
To Suit **HOLDEN VF COMMODORE WAGON 2013 ON**
Part Number **HD96L**
Rating **1200/120 kg**

PLACE THESE INSTRUCTIONS IN THE VEHICLE'S GLOVEBOX AFTER INSTALLATION IS COMPLETED

INSTRUCTION:

1. In the passenger side Wheel well, remove 5x Screws connecting the rear Bumper to the wheel well cover. Repeat for passenger side
2. Remove 3x Scrivets from underneath the Bumper tab, securing the Bumper to the wheel well.
3. Ensure that sensor cables are unplugged, then carefully peel away Bumper and place to the side in a safe area. Remove polystyrene insert from rear of vehicle and dispose.
4. From inside the Boot, unsecure the 2 tie-down points and remove the floor cover.
5. Carefully remove polystyrene flooring and set in a safe place to the side. If removal is difficult, peel away trim from side of boot to allow for easier removal.
6. Remove 2x Bolts securing the tie down bracket. Repeat for opposite side of vehicle
7. Remove Chassis Rail inserts and dispose.
8. Insert Towbar assembly into vehicle chassis. Force may be required to slide arms into the vehicle. Align mounting holes with luggage tie-down points.
9. If required, grind down tab near insert hole to allow easier insertion of Towbar inserts
10. Using Bolts supplied, reinstall luggage tie-down points. Tighten bolts to recommended torque as noted on page 1.
11. Cut rear Bumper skin by following the Holden original factory Bumper indent.

Use a small pilot drill to pierce the skin to allow a small saw or similar device to cut. Clean any raw edges with a file.

Refit the bumper following steps 1 to 6 in reverse.



Wiring Loom Fitting Instructions
To Suit Holden Commodore VF Sedan & Wagon
Part Number 100971-WL

Wiring Loom Installation Instructions
Holden Commodore VF Sedan & Wagon

Part No: 100971-WL

ECU Required: 04839

Tail Harness Length Required: 1200mm

Wiring Loom Installation Time: Approx 20 Mins

Holden Commodore VF Sedan – page 2

Holden Commodore VF Wagon – pages 3

TRAILBOSS

Wiring Loom Fitting Instructions To Suit Holden Commodore VF Sedan & Wagon Part Number 100971-WL

The following steps are for Holden Commodore VF Sedan models. For Holden Commodore VF Wagon models, proceed to Page 3.

1. In the luggage compartment, remove the four screws from the rear trim and then remove the rear trim and the luggage compartment floor carpet.
2. Remove the three fasteners from the LHS luggage compartment trim and then dislodge the trim.
3. Drill a 30mm hole into the rear LHS area of the spare wheel plastic tub lining.
4. In the LHS luggage compartment rear quarter area, locate and connect the (grey) 6-way break-out connector (1) to the trailer patch (P/No: 100971-WL) mating connector (2).
5. Connect the trailer patch ECU connector (3) to the ECU (4) and then mount the ECU to the rear quarter panel using double sided adhesive tape, **ensuring the ECU connector end is pointing down**. Route the trailer patch harness towards the spare wheel well.

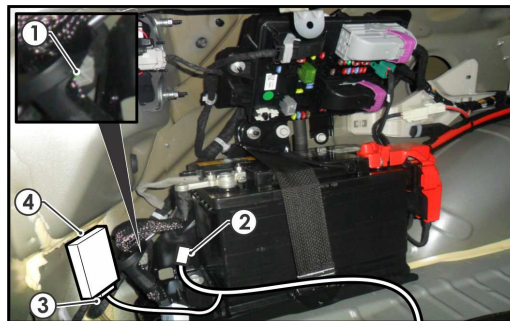

6. From the rear exterior underside of the vehicle, route the tail harness (tail length 1200mm) up through the drilled out 30mm hole and into the vehicle, ensuring the grommet is seated correctly. Secure the trailer patch harness socket head to the towbar mounting plate using the supplied M4 fasteners.
7. In the luggage compartment spare wheel well, connect the trailer harness 8-way connector to the trailer patch mating connector.
8. Test the trailer wiring harness function using a light board or multimeter.
9. Secure all harnesses using cable ties (not supplied). Re-fit all removed parts and secure all fasteners, ensuring there are no squeaks or rattles.
10. Place the fitting instructions in the glove box after fitment.

TRAILBOSS

Wiring Loom Fitting Instructions To Suit Holden Commodore VF Sedan & Wagon Part Number 100971-WL

The following steps are for Holden Commodore VF Wagon models. For Holden Commodore VF Sedan models, go back to Page 2.

1. In the luggage compartment, remove the floor carpet cover and remove the screws and tow hooks.
2. Remove the LHS luggage compartment fuse access panel.
3. At the spare wheel plastic tub lining, drill a 30mm hole (1) into the LHS quarter.

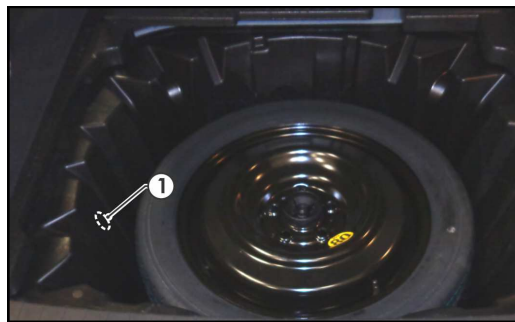

4. In the LHS luggage compartment rear quarter area, locate and connect the (grey) 6-way break-out connector (1) to the trailer patch (P/No: 100971-WL) mating connector (2).
5. Connect the trailer patch ECU connector (3) to the ECU (4) and then mount ECU to the rear quarter sheet metal panel using double sided adhesive tape ensuring the connector end is pointing down.

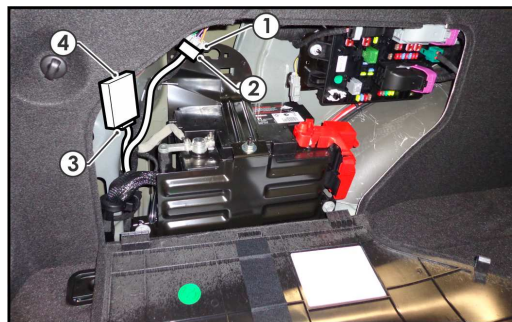

6. Route the trailer patch harness towards the spare wheel well.
7. At the rear exterior underside of the vehicle, route the tail harness (tail length 1200mm) up through the drilled out 30mm hole and into the vehicle, ensuring the grommet is seated correctly.
8. Secure the trailer patch harness socket head to the towbar mounting plate using the supplied M4 fasteners.



Wiring Loom Fitting Instructions
To Suit Holden Commodore VF Sedan & Wagon
Part Number 100971-WL

9. In the luggage compartment spare wheel well, connect the trailer harness 8-way connector to the trailer patch mating connector.
10. Test the trailer wiring harness function using a light board or multimeter.
11. Secure all harnesses using cable ties (not supplied).
12. Re-fit all removed parts and secure all fasteners, ensuring there are no squeaks or rattles.
13. Place the fitting instructions in the glove box after fitment.