

TRAILBOSS

Towbar Fitting Instructions
To Suit MAZDA 6 (SEDAN, HATCH, WAGON, LUXURY SPORTS)
2008 – 03/2010
Part Number QTMA438L
Rating 1500 kg

WARNING:

Do not, drill, cut, weld or otherwise modify the tow bar.

If you are using electric welding on a motor vehicle, **always** check that the vehicle is not equipped with electronic engine or instrument management equipment. Failure to do so could **destroy** any onboard computers. If in doubt, check with the vehicle's manufacturer.

General:

1. Ensure all hardware items have been included refer to assembly diagram.
2. It is recommended that the instructions are read through and completely understood before making any attempt to fit this product.
3. Be wary of any changes to vehicle designs or other accessories that may conflict with the installation of this product.
4. Before drilling ensure that the area is clear of fuel, electrical & other components.
5. All holes drilled into the body panels shall have all burrs & swarf removed then coated with a suitable rust preventative paint.
6. The high tensile fasteners supplied with this product were used to achieve the specified rating. If replacement is required ensure that fasteners of the same rating & quality are used. Contact an authorized **Trailboss** dealer if further information is required.
7. Ensure that all hardware is fastened to torque list below check fasteners on regular basis.
8. Tow bar load rating sticker provided with this product shall be conspicuously located on inside rear end of the driver's door. **(See diagram below).**
9. Trailboss recommends that you check your tow ball to ensure that it complies with the Australian standards **AS 4177.2**.
10. **PLEASE NOTE:** It is advised to remove your lug or tbn when not actually towing so as to produce a clear view of the vehicles registration plate if obscured, and to also provide maximum available departure angle

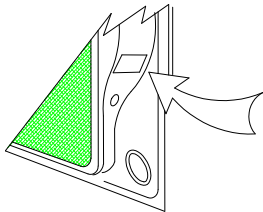

Place load rating sticker
inside driver's door here

FOR TOWING PURPOSES ONLY
For towing capacity details please refer to vehicle owner's manual or to the manufacturer. Overloading can void your warranties.

RECOMMENDED ASSEMBLY TORQUE LISTING

<u>Diameter</u>	<u>Grade 8.8 Bolt</u>
M6	9.5 Nm
M8	21.7 Nm
M10	43.4 Nm
M12	77.3 Nm
M16	189.8 Nm

Tow bar Maintenance and Care.

Trailboss recommends that bolt torque's, as listed below, are routinely and regularly inspected and checked for correct tension. Replace any worn or defective parts.

We recommended to remove Tow Ball Mounts (TBM's, tongues or lugs) when not being used for any considerable length of time.

So as to avoid injury, when not towing it is suggested that the tongue, Pull Pin and R-clip are removed then stored in a safe, clean and dry place, away from excessive moisture.

Hitch Pull Pins and spring "R" clips are regularly checked for proper installation. Replace any worn or defective parts.

TRAILBOSS

Towbar Fitting Instructions
To Suit MAZDA 6 (SEDAN, HATCH, WAGON, LUXURY SPORTS)
2008 – 03/2010
Part Number QTMA438L
Rating 1500 kg

11. Remove bumper bar
 - a. Remove 3 screws inside and 1 under rear mid guard on both sides, refer figure 1.
 - b. Remove 2 screws under the mud guard on both sides.
 - c. Remove 2 plastic trim plugs under the bumper bar
 - d. Remove taillight assembly by removing 3 nuts from inside vehicle refer figure 2.
 - e. Remove 2 screws on top of the bumper, refer figure 3.
 - f. Remove 2 screws inside tailgate cavity (wagon only).
 - g. Disconnect any wiring attached to bumper bar before remove rear bumper.

12. Remove impact beam
 - a. Remove four M10 nuts from each side of rear impact beam, refer figure 4.
 - b. Remove muffler hanger on both side, refer figure 4.
 - c. Remove the impact beam and discard the rear impact beam.

14. Fitment the towbar via
 - a. Position towbar against rear studs and secure with 6 M10x1.25 nuts supplied refer figure 4.
 - b. Use M10x40 bolt, flat washer, tow hook plate, and M10x1.25 nuts provided to secure the tow hook mount refer figure 5.
 - c. Torque all bolts and nuts to recommended torque refer page1.
 - d. Reinstall muffler hanger on both side.

15. Bumper cut detail
 - a. Establish centre line of bumper bar then mark out as detailed in figure 6
 - b. Cut section of bumper with modified hacksaw or similar device.
 - c. For SEDAN/HATCH measure 20mm from the paint line as the cut point.
 - d. For WAGON measure 40mm from the paint line as the cut refer figure 6 .
 - e. For LUXURY SPORTS measure 60mm from the paint line as the cut refer figure 6
 - f. Reinstall the bumper in reverse order.

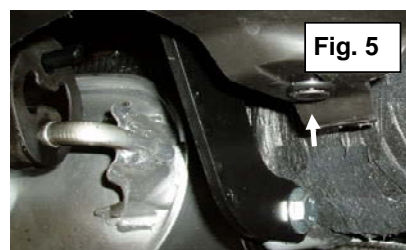
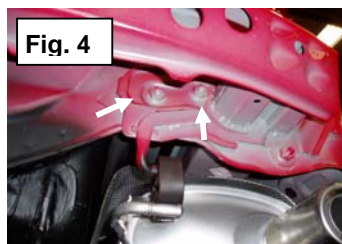
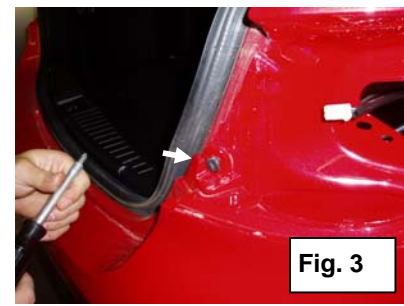
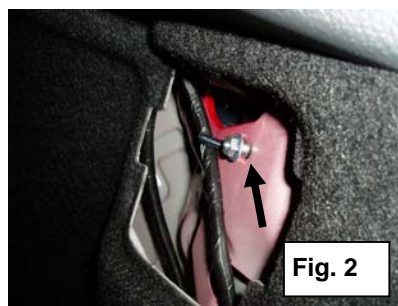

Towbar Fitting Instructions
 To Suit MAZDA 6 (SEDAN, HATCH, WAGON, LUXURY SPORTS)
 2008 – 03/2010
 Part Number QTMA438L
 Rating 1500 kg

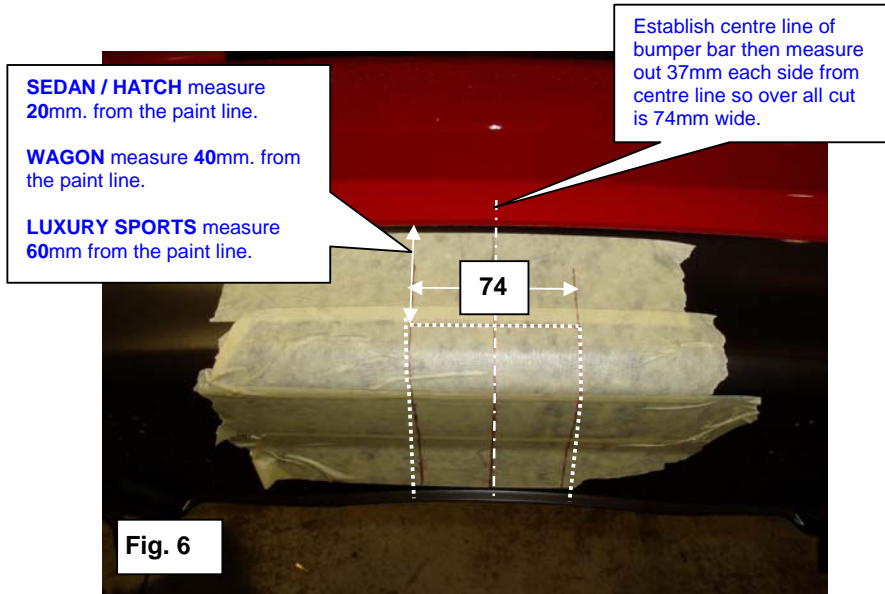

QTMA438L COMPLETE ASSEMBLY

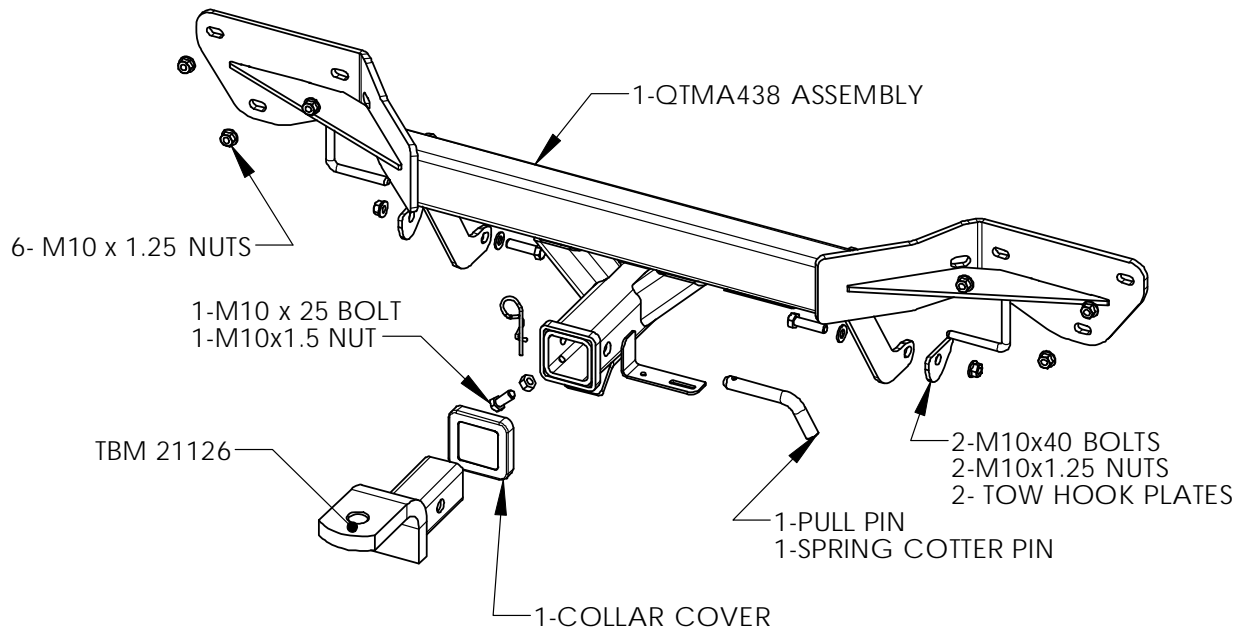



Wiring Loom Fitting Instructions
To Suit Mazda6 GH11
Part Number 100077-WL

Wiring Loom Installation Instructions

**Mazda6 GH11
Part No: 100077-WL**

**Kit Part Includes:
Tail Length Required: 1200mm
RPA Override Switch Part No: 04848 (If Fitted)**

Wiring Loom Installation Time: Approx 30 Mins



Wiring Loom Fitting Instructions
To Suit Mazda6 GH11
Part Number 100077-WL

1. All steps apply to sedan, hatch and wagon models.
2. Remove the bumper fascia by removing all of its fasteners.
3. At the rear of the vehicle luggage compartment, remove the rear sunshade and the floor carpet. Fold down the rear seats.
4. Remove the rear trim by removing the trim fasteners.
5. Remove the luggage LHS and RHS trims by removing the trim fasteners.
6. At the rear of the vehicle, remove the rear grommet. Drill out the grommet hole to Ø31mm. File down any rough or sharp edges and spray on rust inhibitor.
7. Mount the tail harness (tail length 1200mm) to the towbar mounting bracket using M4 fasteners (not supplied). Route the tail harness connector into the grommet hole. Adjust the tail harness grommet into place ensuring it is seated correctly. Secure the tail harness grommet into place using a cable tie (not supplied).
8. Inside the luggage compartment, secure the trailer patch harness (P/No: 100077-WL) earth terminal onto the LHS vehicle earthing point. Connect the tail harness connector to the trailer patch harness mating connector.
9. Disconnect the LHS vehicle tail light assembly 2-way connectors and patch the trailer patch harness connectors in between.
10. Route the trailer patch harness wire black terminal to the white connector located above the LHS wheel arch on top of the seat belt mechanism. Locate the connector BLACK/BLUE reverse wire and secure the supplied ezy tap onto the BLACK/BLUE wire. Connect the trailer harness wire terminal onto the BLACK/BLUE connector wire.
11. On the RHS of the vehicle, disconnect the RHS tail light assembly 2-way and 4-way connectors. Route the trailer patch harness 2-way and 4-way connectors to the RHS of the vehicle and patch them in between.
12. Refit the rear bumper fascia.
13. Test the Trailer socket using a light board or multi-meter.
14. Secure all harnesses using cables ties (not supplied).
15. Refit all removed parts and secure all fasteners.
16. Place instructions in glove box after fitment.