

TRAILBOSS

Towbar Fitting Instructions
To Suit **SKODA SUPERB 03/2009 ON**
Part Number **QTSK001L**
Rating **1500/75 kg**

PLACE THESE INSTRUCTIONS IN THE VEHICLE'S GLOVEBOX AFTER INSTALLATION IS COMPLETED

WARNING:

1. Do not, drill, cut, weld or otherwise modify the tow bar.
2. If you are using electric welding on a motor vehicle, **always** check that the vehicle is not equipped with electronic engine or instrument management equipment. Failure to do so could **destroy** any onboard computers. If in doubt, check with the vehicle's manufacturer.
3. The high tensile fasteners supplied with this product were used to achieve the specified rating. If replacement is required ensure that fasteners of the same rating & quality are used. Contact an authorised **Trailboss** dealer if further information is required.

General:

1. Ensure all hardware items have been included refer to assembly diagram.
2. It is recommended that the instructions are read through and completely understood before making any attempt to fit this product.
3. Be wary of any changes to vehicle designs or other accessories that may conflict with the installation of this product.
4. Before drilling ensure that the area is clear of fuel, electrical & other components.
5. All holes drilled into the body panels shall have all burrs & swarf removed then coated with a suitable rust preventative paint.
6. For vehicles that require the bumper to be cut. Ensure cut out area is in correct position on the vehicle prior to cutting the bumper.
7. The high tensile fasteners supplied with this product were used to achieve the specified rating. If replacement is required ensure that fasteners of the same rating & quality are used. Contact an authorized **Trailboss** dealer if further information is required.
8. Ensure that all hardware is fastened to torque list below check fasteners on regular basis.
9. Tow bar load rating sticker provided with this product shall be conspicuously located on inside rear end of the driver's door. **(See diagram below)**.
10. Trailboss recommends that you check your tow ball to ensure that it complies with the Australian standards **AS 4177.2**.
11. **PLEASE NOTE:** It is advised to remove your lug or tbm when not actually towing so as to produce a clear view of the vehicles registration plate if obscured, and to also provide maximum available departure angle
12. Pull Pin must be fit in down position.

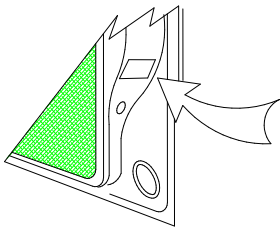

Place load rating sticker
inside driver's door here

FOR TRAILER TOWING PURPOSES ONLY
For towing capacity details please refer to vehicle owner's manual or to the manufacturer. Overloading can void your warranties.

RECOMMENDED ASSEMBLY TORQUE LISTING

Diameter	Grade 8.8 Bolt
M6	9.5 Nm
M8	21.7 Nm
M10	43.4 Nm
M12	77.3Nm
M14	146 Nm
M16	189.8 Nm

Tow bar Maintenance and Care.

Trailboss recommends that bolt torque's, as listed below, are routinely and regularly inspected and checked for correct tension. Replace any worn or defective parts.

We recommended to remove Tow Ball Mounts (TBM's, tongues or lugs) when not being used for any considerable length of time.

So as to avoid injury, when not towing it is suggested that the tongue, Pull Pin and R-clip are removed then stored in a safe, clean and dry place, away from excessive moisture.

Hitch Pull Pins and spring "R" clips are regularly checked for proper installation. Replace any worn or defective parts.

TRAILBOSS

Towbar Fitting Instructions
 To Suit **SKODA SUPERB 03/2009 ON**
 Part Number **QTSK001L**
 Rating **1500/75 kg**

PLACE THESE INSTRUCTIONS IN THE VEHICLE'S GLOVEBOX AFTER INSTALLATION IS COMPLETED

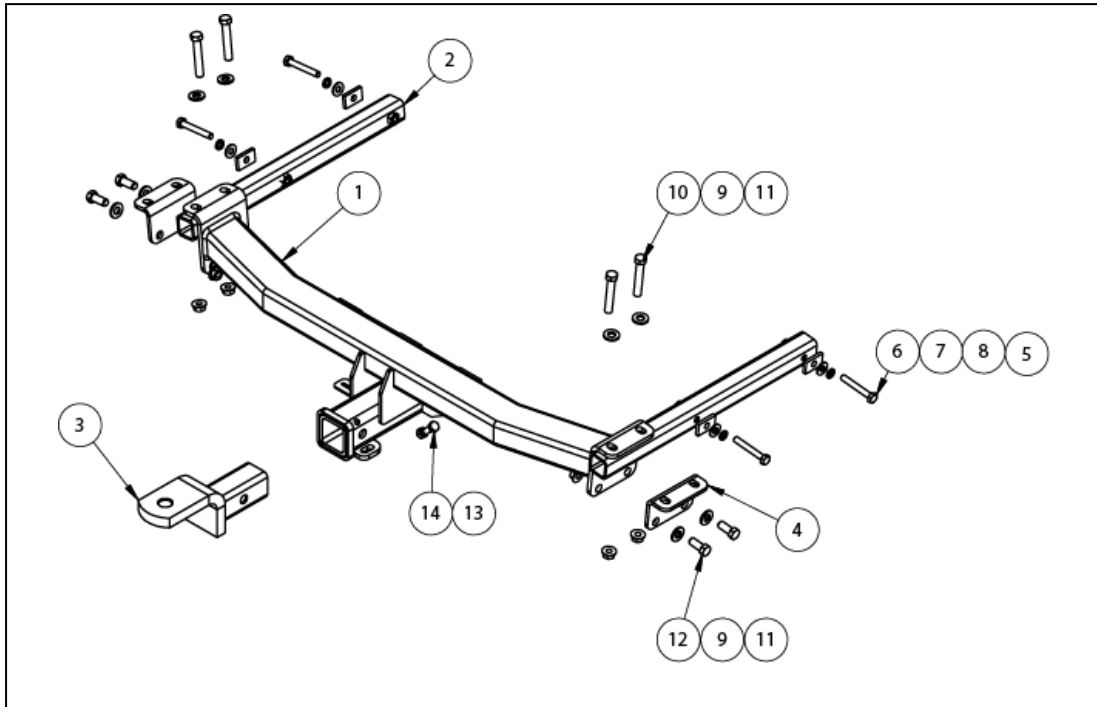

QTY	DESCRIPTION	ITEM NO
1	WELDED ASSEMBLY	1
2	WELDED TUBEMATIC ARM	2
1	TBM	3
2	LOOSE SIDE MOUNT	4
4	LOOSE PLATE 40x25x6	5
4	BOLT M10x70x1.5	6
4	M10x3.5x2.5 SPRING WASHER	7
4	WASHER FLAT M10x23x2 Z/P	8
8	WASHER FLAT 1/2"x1 1/8"x1/8	9
4	M12x75 1.75P BOLT	10
8	M12x1.75P WHIZZ NUT	11
4	M12x30 BOLT 1.75P	12
1	HEX NUT M10x1.5	13
1	BOLT M10-1.50x25	14

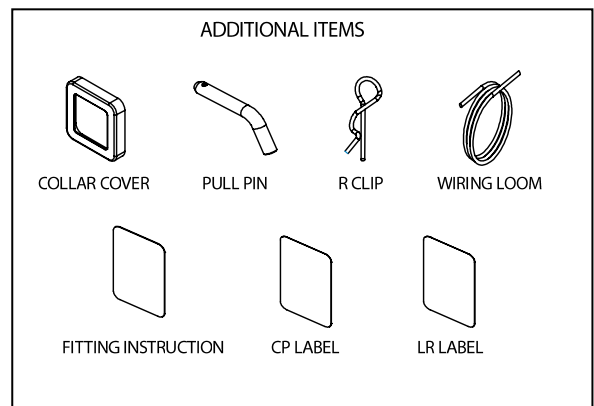



Towbar Fitting Instructions
To Suit **SKODA SUPERB 03/2009 ON**
Part Number **QTSK001L**
Rating **1500/75 kg**

PLACE THESE INSTRUCTIONS IN THE VEHICLE'S GLOVEBOX AFTER INSTALLATION IS COMPLETED

INSTRUCTION:

1. Unplug the 2 Screw Covers and remove the 2 Screws from each side of Rear Tail Light.
2. Disconnect Rear Globe Connectors which located behind Grommet in each Tail Cavity.
3. Remove 3 Screws from inside of each Rear Wheel Arch on both side.
4. Remove 1 Screw from the bottom of Wheel Arch only on Driver Side.
5. Remove 1 Screw from top of the Rear Bumper to the Rear Panel. Repeat other side.
6. Remove 5 Screws from underneath the Bumper.
7. Remove M6 Nuts from the Tail Light Cavity on each side. Remove 3 Plastic Scrivets from the Tail Light Cavity on each side. Dislodge Rear Bumper and disconnect Wiring Connectors. Place Bumper in a safe place.

CAUTION: Some force may be required. Two person lift required.

8. Lower the Exhaust Hanger and the Heat Shield by losing the mounting Screws for better access Towbar fitment.
9. Remove the Impact Beam and discard them.
10. Insert the Sidearms into the Chassis Rail and mount the Brackets.
11. Cut the Bumper at the centre as shown.
12. Locate the Towbar onto the Vehicle by using relevant fasteners. See Assembly Drawing on page2.
13. Refit the Exhaust Muffler Hangers and Bumper in the reverse order of removal.
14. Tighten all fastener in Torque specified on Page1.

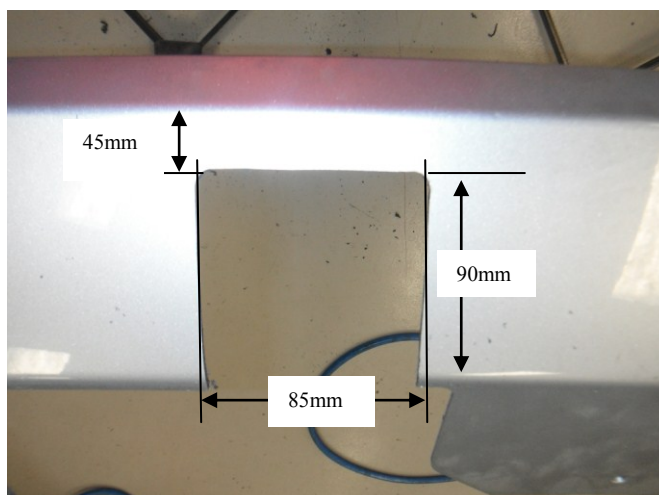



Wiring Loom Fitting Instructions
To Suit Volkswagen Passat MY12 & Skoda Superb MY12
Part Number 100831-WL

Wiring Loom Installation Instructions

Volkswagen Passat MY12
Skoda Superb MY12

Part No: 100831-WL
ECU Required: 04836

Tail Harness Length Required: 1800mm

Wiring Loom Installation Time: Approx 45 Mins

Volkswagen Passat – Page 2-4
Skoda Superb – Page 5-7

Wiring Loom Fitting Instructions To Suit Volkswagen Passat MY12 & Skoda Superb MY12 Part Number 100831-WL

The following Steps are for Volkswagen Passat only. For Skoda Superb, please proceed to Page 5.

1. In the luggage compartment, remove the floor carpet cover.
2. Remove the rear luggage compartment trim by pulling up in an upwards direction.
3. On the RHS of the luggage compartment trim, remove the screw.
4. Dislodge the luggage compartment trim lining from the plastic trim.

Repeat for the LHS.

5. Carefully dislodge the RHS luggage compartment trim, and disconnect the 12v power connector and light connector.
6. Inside the luggage compartment, on the LHS rear quarter panel, drill a Ø30mm hole (1) next to the existing vehicle grommet.

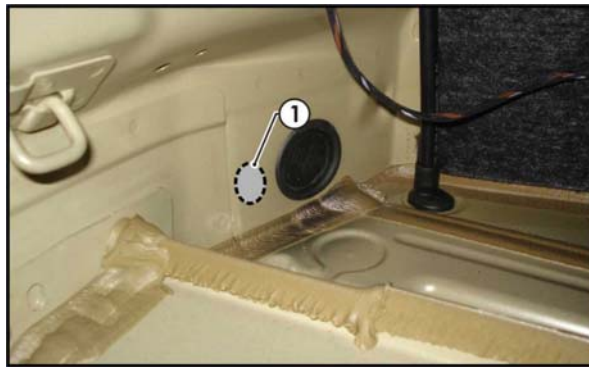

7. File any rough or sharp edges and spray rust inhibitor.
8. On the RHS of the luggage compartment, following the table below, connect the ezy-tap (1) to the vehicle 'BLACK / GREEN' R.IND wire (2), and then connect the trailer patch terminal (3) to the ezy-tap (1).

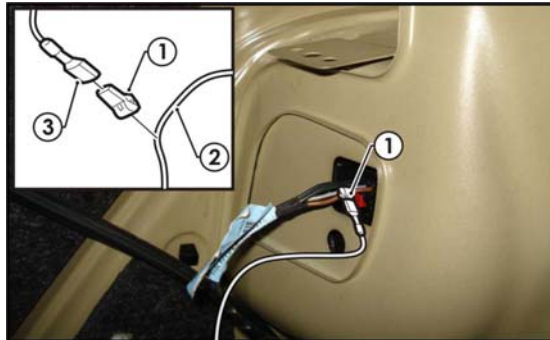

Function	Trailer Patch	Vehicle Connector
R.IND	GREEN / BLACK	BLACK / GREEN

Wiring Loom Fitting Instructions To Suit Volkswagen Passat MY12 & Skoda Superb MY12 Part Number 100831-WL

9. Route the trailer harness (P/No: 100831-WL), along the rear luggage compartment panel towards the LHS of the vehicle.
10. On the LHS of the luggage compartment, following the table below, connect the ezy-tap (1) to the corresponding vehicle wires (2), and then connect the trailer patch terminal (3) to the ezy-tap (1).

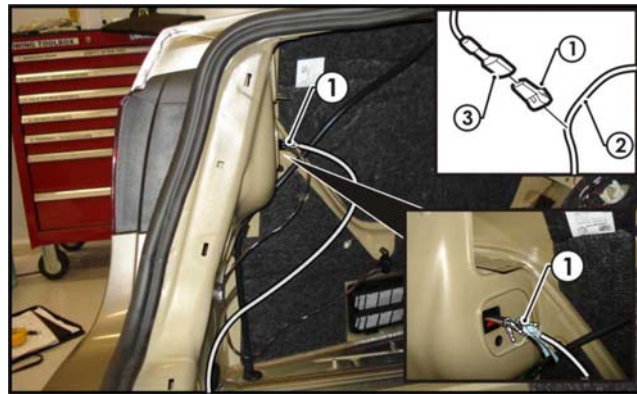

Function	Trailer Patch	Vehicle Connector
L.IND	YELLOW / BLACK	BLACK
REVERSE	BLACK / WHITE	GREY / WHITE
TAIL / BRAKES	BROWN / BLACK	BROWN / GREY

11. Connect the trailer patch ground ring terminal to the vehicle grounding point.
12. Apply double sided tape to the ECU (04836) and adhere it to the vehicle sheet metal on the LHS of the luggage compartment wheel arch.
13. Connect the trailer patch 12-way connector to the ECU (04836).

Wiring Loom Fitting Instructions To Suit Volkswagen Passat MY12 & Skoda Superb MY12 Part Number 100831-WL

14. Route the 'ORANGE' power wire (1) towards the red connector on the LHS of the luggage compartment.
15. Following the table below, connect the ezy-tap (2) to the corresponding power vehicle wire (3), then connect the trailer patch terminal (4) to the ezy-tap (2).

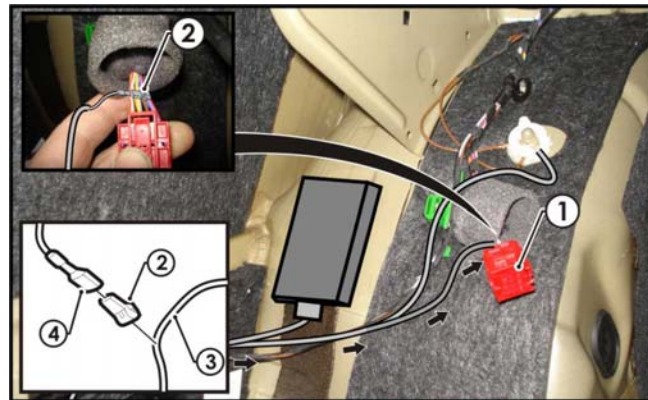

Function	Trailer Patch	Vehicle Connector
POWER	ORANGE	PURPLE / RED

16. Mount the trailer socket to the tow bar mounting bracket using M4 fasteners (not supplied).
17. Route the tail harness across the tow bar towards the RHS of the vehicle and up through the previously drilled out hole.
18. Ensure the tail harness grommet is seated correctly and secure in place using a cable tie (not supplied).
19. Connect the tail harness (tail length 1200mm) 8-way connector to the trailer patch mating 8-way connector.
20. Test the trailer patch function using a light board or multi meter.
21. Secure all harnesses using cable ties (not supplied).
22. Re-fit all removed parts and secure all fasteners, ensuring there are no squeaks or rattles.
23. Place the fitting instructions in the glove box after fitment.

Wiring Loom Fitting Instructions To Suit Volkswagen Passat MY12 & Skoda Superb MY12 Part Number 100831-WL

The following Steps are for Skoda Superb only. For Volkswagen Passat, please refer to Page 2.

1. In the luggage compartment remove the floor carpet cover.
2. Remove the two screws and loosen the 10mm plastic bolts behind the emergency kit on the rear luggage compartment trim.
3. Remove the rear luggage compartment trim by pulling up in an upwards direction.

Note: Ensure to remove 2-pin connector attached to this trim before removing.

4. On the RHS of the luggage compartment trim, remove the four cargo hooks located across the top of the luggage compartment trim as indicated.
5. Dislodge the luggage compartment trim.

Repeat steps 4 & 5 for LHS.

6. Inside the luggage compartment, on the LHS rear quarter panel, drill a Ø30mm hole next to the existing vehicle grommet.
7. File any rough or sharp edges and spray rust inhibitor.
8. On the RHS of the luggage compartment, following the table below, connect the ezy-tap (1) to the vehicle 'BLACK / GREEN' R.IND wire, then connect the trailer patch terminal (3) to the ezy-tap (1).

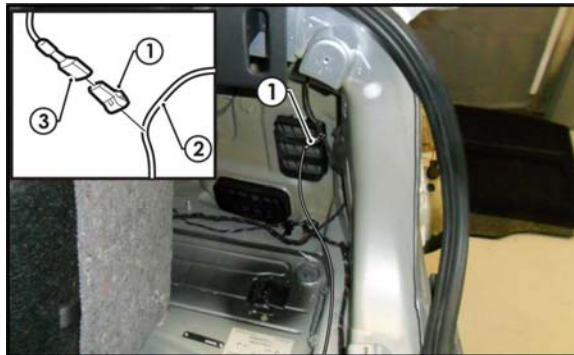

Function	Trailer Patch	Vehicle Connector
R.IND	GREEN BLACK	BLUE / BROWN

9. Route the trailer harness (P/No: 100831-WL) along the rear luggage compartment panel towards the LHS of the vehicle.

Wiring Loom Fitting Instructions To Suit Volkswagen Passat MY12 & Skoda Superb MY12 Part Number 100831-WL

10. On the LHS of the luggage compartment, following the table below, connect the ezy-tap (1) to the corresponding vehicle wires (2), then connect the trailer patch terminal (3) to the ezy-tap (1).

Note: The REVERSE wire can be located near the wheel arch.

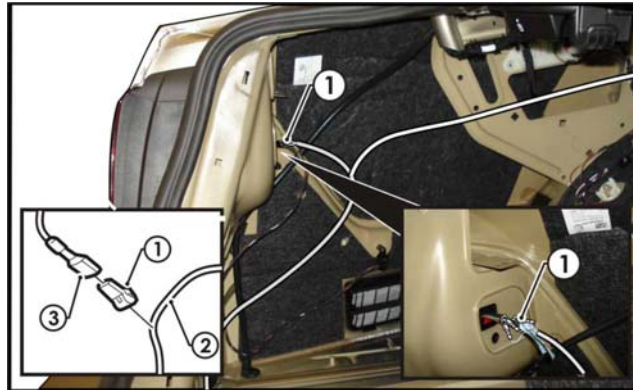

Function	Trailer Patch	Vehicle Connector
L.IND	YELLOW / BLACK	BLACK / WHITE
REVERSE	BLACK / WHITE	BLUE / BLACK
TAIL / BRAKES	BROWN / BLACK	RED / BLACK

11. On the LHS of the luggage compartment wheel arch, connect the trailer patch ground ring terminal to the vehicle grounding point.
12. Apply double sided tape to the ECU (04836) and adhere it to the vehicle sheet metal on the LHS of the luggage compartment wheel arch.
13. Connect the trailer patch 12-way connector to the ECU (04836).

Wiring Loom Fitting Instructions To Suit Volkswagen Passat MY12 & Skoda Superb MY12 Part Number 100831-WL

14. Route the 'ORANGE' power wire towards the red connector (1) on the LHS of the luggage compartment.
15. Following the table below, connect the ezy-tap (2) to the corresponding power vehicle wire (3), then connect the trailer patch terminal (4) to the ezy-tap (2).

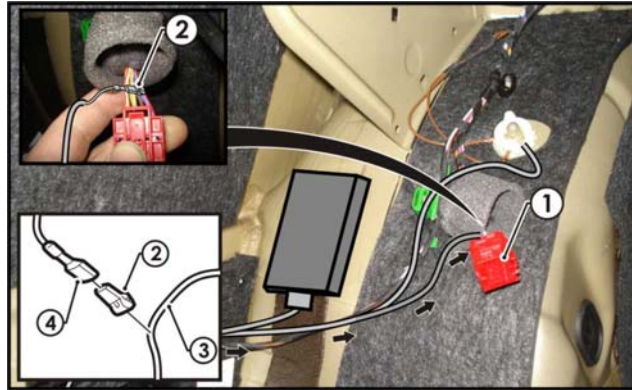

Function	Trailer Patch	Vehicle Connector
+12V	ORANGE	PURPLE / RED

16. Mount the trailer socket to the tow bar mounting bracket using M4 fasteners (not supplied).
17. Route the tail harness across the tow bar towards the RHS of the vehicle and up through the previously drilled out hole.
18. Ensure the tail harness grommet is seated correctly and secure in place using a cable tie (not supplied).
19. Connect the tail harness (tail length 1200mm) 8-way connector to the trailer patch mating 8-way connector.
20. Test the trailer patch function using a light board or multi meter.
21. Secure all harnesses using cable ties (not supplied).
22. Re-fit all removed parts and secure all fasteners, ensuring there are no squeaks or rattles.
23. Place the fitting instructions in the glove box after fitment.