

TRAILBOSS

Towbar Fitting Instructions To Suit **SUBARU IMPREZA SEDAN 2012 ON** Part Number **SB30L** Rating **1200/120 kg**

PLACE THESE INSTRUCTIONS IN THE VEHICLE'S GLOVEBOX AFTER INSTALLATION IS COMPLETED

WARNING:

1. Do not, drill, cut, weld or otherwise modify the tow bar.
2. If you are using electric welding on a motor vehicle, **always** check that the vehicle is not equipped with electronic engine or instrument management equipment. Failure to do so could **destroy** any onboard computers. If in doubt, check with the vehicle's manufacturer.
3. The high tensile fasteners supplied with this product were used to achieve the specified rating. If replacement is required ensure that fasteners of the same rating & quality are used. Contact an authorised **Trailboss** dealer if further information is required.

General:

1. Ensure all hardware items have been included refer to assembly diagram.
2. It is recommended that the instructions are read through and completely understood before making any attempt to fit this product.
3. Be wary of any changes to vehicle designs or other accessories that may conflict with the installation of this product.
4. Before drilling ensure that the area is clear of fuel, electrical & other components.
5. All holes drilled into the body panels shall have all burrs & swarf removed then coated with a suitable rust preventative paint.
6. For vehicles that require the bumper to be cut. Ensure cut out area is in correct position on the vehicle prior to cutting the bumper.
7. The high tensile fasteners supplied with this product were used to achieve the specified rating. If replacement is required ensure that fasteners of the same rating & quality are used. Contact an authorized **Trailboss** dealer if further information is required.
8. Ensure that all hardware is fastened to torque list below check fasteners on regular basis.
9. Tow bar load rating sticker provided with this product shall be conspicuously located on inside rear end of the driver's door. **(See diagram below)**.
10. Trailboss recommends that you check your tow ball to ensure that it complies with the Australian standards **AS 4177.2**.
11. **PLEASE NOTE:** It is advised to remove your lug or tbn when not actually towing so as to produce a clear view of the vehicles registration plate if obscured, and to also provide maximum available departure angle
12. Pull Pin must be fit in down position.

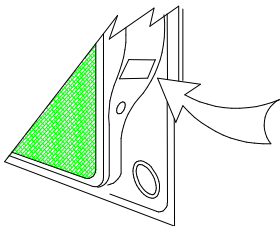

Place load rating sticker
inside driver's door here

FOR TRAILER TOWING PURPOSES ONLY
For towing capacity details please refer to vehicle owner's manual or to the manufacturer. Overloading can void your warranties.

RECOMMENDED ASSEMBLY TORQUE LISTING

Diameter	Grade 8.8 Bolt
M6	9.5 Nm
M8	21.7 Nm
M10	43.4 Nm
M12	77.3Nm
M14	146 Nm
M16	189.8 Nm

Tow bar Maintenance and Care.

Trailboss recommends that bolt torque's, as listed below, are routinely and regularly inspected and checked for correct tension. Replace any worn or defective parts.

We recommended to remove Tow Ball Mounts (TBM's, tongues or lugs) when not being used for any considerable length of time.

So as to avoid injury, when not towing it is suggested that the tongue, Pull Pin and R-clip are removed then stored in a safe, clean and dry place, away from excessive moisture.

Hitch Pull Pins and spring "R" clips are regularly checked for proper installation. Replace any worn or defective parts.

TRAILBOSS

Towbar Fitting Instructions
 To Suit **SUBARU IMPREZA SEDAN 2012 ON**
 Part Number **SB30L**
 Rating **1200/120 kg**

PLACE THESE INSTRUCTIONS IN THE VEHICLE'S GLOVEBOX AFTER INSTALLATION IS COMPLETED

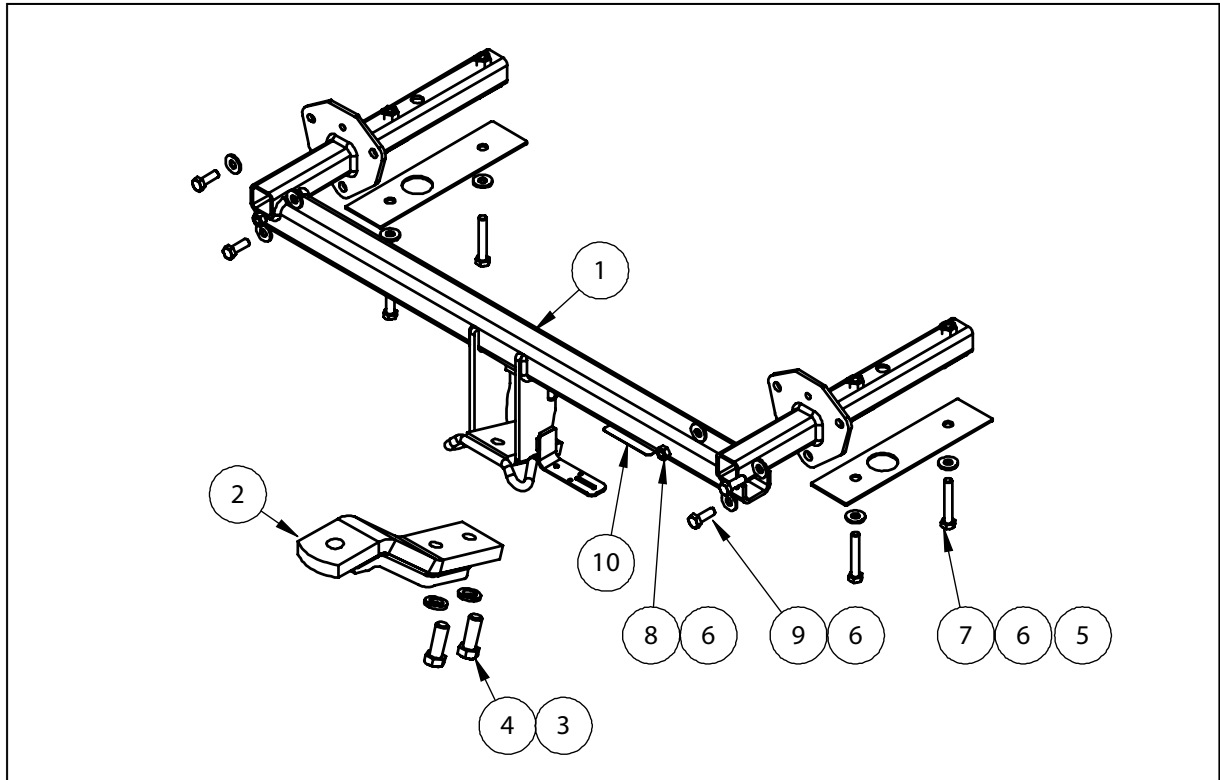

QTY	DESCRIPTION	ITEM NO
1	SUBARU IMPREZA WELDED ASSY	1
1	LUG ASSEMBLY	2
2	M16x5x3.5 SPRING WASHER	3
2	M16x45 2.0P BOLT	4
2	WASHER PLATE	5
10	WASHER FT M10x25.4x3	6
4	M10x65x1.5 BOLT	7
2	NUT HX M10-1.25	8
4	BOLT M10-1.25x30	9
1	ACRYLIC CP LABEL	10

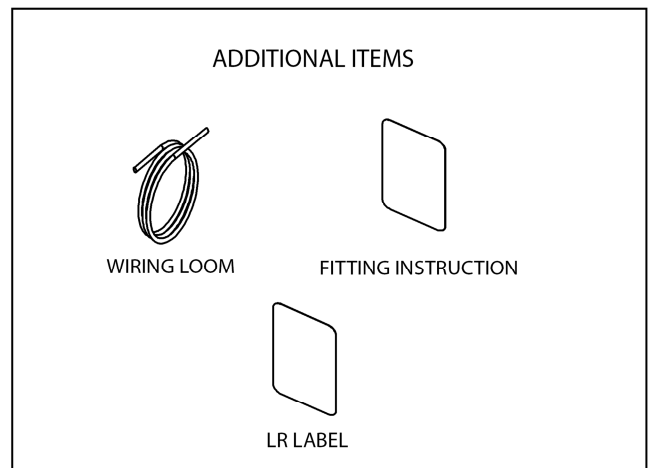



Towbar Fitting Instructions
To Suit **SUBARU IMPREZA SEDAN 2012 ON**
Part Number **SB30L**
Rating **1200/120 kg**

PLACE THESE INSTRUCTIONS IN THE VEHICLE'S GLOVEBOX AFTER INSTALLATION IS COMPLETED

INSTRUCTION:

1. Remove 1xScrivet from Bumper on the inside of the Wheel Arch for both the LH &RH side.
2. Remove 2x Scrivet from the underside of Bumper Bar for both the LH & RH side. Open Boot and then firmly pull on Bumper Bar to remove from Plastic Clips.
3. Remove 2 x Bolts and 1 x Nut from Impact Beam for both the LH & RH side and discard Impact Beam and Bolts.
4. Drop Exhaust Muffler and remove Heat Shield. Remove 3 x Rubber Grommet from the Chassis Rails on both the LH & RH side. Offer Towbar to vehicle and loosely tighten all Nuts, Bolts and Washer Plates.
5. Tighten all Bolts to the Torque Specifications provided.
6. Create a Bumper Cut in the middle of the Bumper Bar on the bottom surface measuring a 115mm wide.

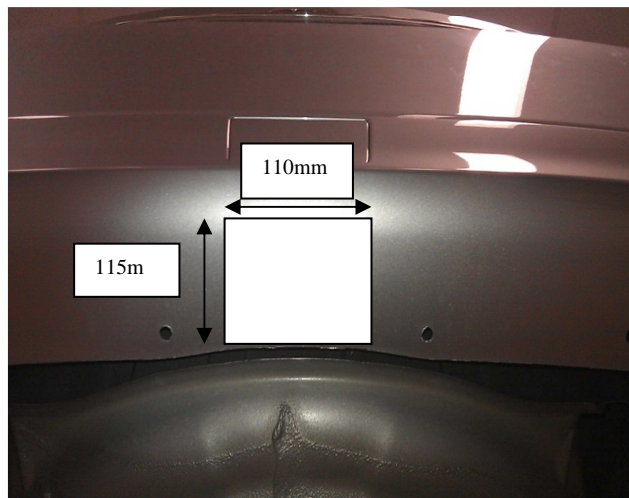



Wiring Loom Fitting Instructions
To Suit Subaru Liberty (Sedan & Wagon), Outback & Forester
(2003 – Onwards), Subaru XV, Impreza (2007 – 2012),
Impreza (2012 – Onwards)
Part Number 100201-WL

Wiring Loom Installation Instructions

Subaru Liberty (Sedan & Wagon),
Outback & Forester, Subaru XV, Impreza (2007 – Onwards),
Impreza (2012 – Onwards)
Part No: 100201-WL

Tail Harness Length Required:
Liberty / Outback - 1200mm (Wagon)
Liberty – 1800mm (Sedan)
Forester – 1800mm
Subaru XV – 1200mm (WLT024)
Subaru Impreza (2007 – 2012) -1200mm
Subaru Impreza (2012 – Onwards) – 1200mm (WLT024)

Liberty Wagon & Outback – Page 2
Liberty Sedan – Page 3
Forester – Page 4
Subaru XV – Pages 5 – 6
Subaru Impreza (2007 – 2012) & Impreza (2012 – Onwards) – Pages 7 – 8

Wiring Loom Installation Time: Approx. 25 Mins



Wiring Loom Fitting Instructions
To Suit Subaru Liberty (Sedan & Wagon), Outback & Forester
(2003 – Onwards), Subaru XV, Impreza (2007 – 2012),
Impreza (2012 – Onwards)
Part Number 100201-WL

The following steps are for the Liberty Wagon & Outback models only. For Liberty Sedan models, proceed to page 3. For Forester models, proceed to page 4. For Subaru XV models, proceed to page 5. For Subaru Impreza (2007 – 2012) & Impreza (2012 – Onwards), proceed to page 7.

1. In the luggage compartment area, remove the rear sun shade and all floor trims.
2. Remove the LHS and RHS tail lights.
3. Remove the rear bumper fascia fasteners and the rear bumper fascia.
4. Remove the rear trim.
5. Remove the rear passenger seat cushion.
6. Remove the LHS rear passenger sill trim.
7. Remove the two fasteners from the LHS rear luggage compartment trim.
8. Remove the LHS luggage compartment trim fasteners and then remove the LHS luggage compartment trim.
9. On the outer LHS rear quarter of the vehicle, locate and remove the grommet next to the vent. Widen the grommet hole to Ø30mm using a step drill.
10. File any rough or sharp edges and spray on rust inhibitor.

Note: For vehicles fitted with sunroofs, drill a Ø2mm pilot hole in the area below the sunroof drain. Drill out the hole to Ø30mm using a step drill. File any sharp or rough edges and spray on rust inhibitor.

11. Secure the tail harness socket (tail length 1200mm) to the towbar mounting bracket using M4 fasteners (not supplied).
12. Route the tail harness along the towbar and into the LHS rear quarter grommet.
13. Inside the luggage compartment LHS; retrieve the tail harness from the grommet hole ensuring that the tail harness grommet is seated correctly.
14. Locate and free the vehicle 10-way female break out connector.
15. Connect the trailer wiring harness (100201-WL) to the tail harness.
16. Connect the trailer wiring harness to the break out connector.
17. Test the trailer wiring harness function using a light board or multimeter.
18. Secure all harnesses using cables ties (not supplied).
19. Re-fit all removed parts and secure all fasteners, ensuring there are no squeaks or rattles.
20. Place the instructions in glove box after fitment.



Wiring Loom Fitting Instructions
To Suit Subaru Liberty (Sedan & Wagon), Outback & Forester
(2003 – Onwards), Subaru XV, Impreza (2007 – 2012),
Impreza (2012 – Onwards)
Part Number 100201-WL

The following steps are for Liberty Sedan models only. For Forester models, proceed to page 4. For Liberty Wagon & Outback models, refer to page 2. For Subaru XV, proceed to page 5. For Subaru Impreza (2007 – 2012) & Impreza (2012 – Onwards), proceed to page 7.

1. Remove the rear bumper from the vehicle.
2. Remove the luggage compartment floor carpet.
3. Remove the rear trim by first removing the indicated fasteners.
4. Remove the LHS luggage compartment trim by first removing the two fasteners.
5. On the outer LHS rear quarter of the vehicle, locate and remove the grommet next to the vent (in between the rear wheel arch and the vent). Widen the grommet hole to Ø30mm using a step drill. File the grommet hole of any rough or sharp edges and spray on rust inhibitor.

Note: For vehicles fitted with sunroofs, drill a Ø2mm pilot hole in the area below the sunroof drain. Drill out the hole to Ø30mm using a step drill. File any sharp or rough edges and spray on rust inhibitor.

6. Secure the tail harness socket (tail length 1800mm) to the towbar mounting bracket using M4 fasteners (not supplied).
7. Route the tail harness along the towbar and into the LHS rear quarter grommet.
8. Slide the tail harness grommet into the desired position, ensuring that it is seated correctly into the vehicle grommet hole. Secure with a cable tie (not supplied).
9. Connect the tail harness 10-way connector into the trailer wiring harness (P/no: 100201-WL) 10-way mating connector.
10. Route the trailer wiring harness towards the vehicle break out connector, located at the rear of the vehicle near the LHS of the wheel well.
11. Connect the trailer wiring harness to the vehicle break out connector.
12. Re-fit the rear bumper fascia.
13. Secure all harnesses to the vehicle using cable ties (not supplied).
14. Test the trailer wiring harness function using a trailer light board or multimeter.
15. Re-fit all removed parts and secure all fasteners.
16. Place the instructions in the glove box after fitment.



Wiring Loom Fitting Instructions
To Suit Subaru Liberty (Sedan & Wagon), Outback & Forester
(2003 – Onwards), Subaru XV, Impreza (2007 – 2012),
Impreza (2012 – Onwards)
Part Number 100201-WL

The following steps are for Forester models only. For Liberty Sedan models, refer to page 3. For Liberty Wagon & Outback models, refer to page 2. For Subaru XV, proceed to page 5. For Subaru Impreza (2007 – 2012) & Impreza (2012 – Onwards), proceed to page 7.

1. In the LHS of the luggage compartment, remove the tool tray by first removing the two clips.
2. On the outer LHS rear quarter of the car, locate and remove the grommet near the vent. Widen the grommet hole to Ø30mm using a step drill.
3. File any rough or sharp edges and spray on rust inhibitor.

Note: For vehicles fitted with sunroofs, drill an Ø2mm pilot hole in the area below the sunroof drain. Drill out the hole to Ø30mm using a step drill. File any rough or sharp edges and spray on rust inhibitor.

4. Secure the tail harness socket (tail length 1200mm) to the towbar mounting bracket using M4 fasteners (not supplied).
5. Route the tail harness along the towbar and into the LHS rear quarter grommet.
6. Inside the LHS of the luggage compartment, retrieve the tail harness from the grommet hole ensuring that the tail harness grommet is seated correctly.
7. Locate and free the vehicle 10-way female break out connector.
8. Connect the trailer wiring harness (100201-WL) to the tail harness.
9. Connect the trailer wiring harness to the break out connector.
10. Test the trailer harness function using a light board or multimeter.
11. Secure all harnesses using cables ties (not supplied).
12. Re-fit all removed parts and secure all fasteners, ensuring there are no squeaks or rattles.
13. Place the instructions in glove box after fitment.

TRAILBOSS

Wiring Loom Fitting Instructions To Suit Subaru Liberty (Sedan & Wagon), Outback & Forester (2003 – Onwards), Subaru XV, Impreza (2007 – 2012), Impreza (2012 – Onwards) Part Number 100201-WL

The following steps are for Subaru XV models only. For Liberty Wagon & Outback models, refer to page 2. For Liberty Sedan models, refer to page 3. For Forester models, refer to page 4. For Subaru Impreza (2007 – 2012) & Impreza (2012 – Onwards), proceed to page 7.

1. In the luggage compartment, remove the floor carpet cover and the parcel shelf.
2. Remove the two luggage compartment storage trays by first removing the clips.
3. Remove the rear luggage compartment trim by first removing the two clips and pulling in an upwards direction.
4. Remove the LHS upper 'C' pillar trim by releasing the one screw.
5. Dislodge the LHS luggage compartment trim by removing the two screws.
6. On the LHS rear quarter panel, connect the trailer wiring harness (100201-WL) connector to the vehicle break out connector.
7. To enable the RPA cutout, splice to the loose GREY/BLACK wire from the tail harness into Pin 1 of the connector (1).
8. On the tail harness splice the GREY wire (2) back into any ground wire of the harness (3).

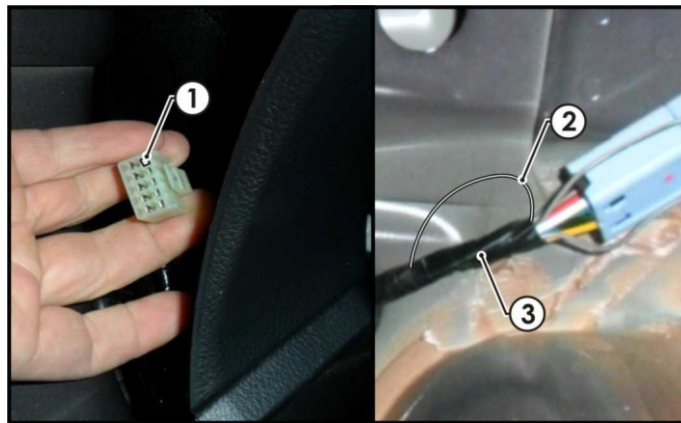

TRAILBOSS

Wiring Loom Fitting Instructions To Suit Subaru Liberty (Sedan & Wagon), Outback & Forester (2003 – Onwards), Subaru XV, Impreza (2007 – 2012), Impreza (2012 – Onwards) Part Number 100201-WL

9. Route the trailer wiring harness (1) along the rear luggage compartment, towards the existing vehicle grommet (2) as shown.

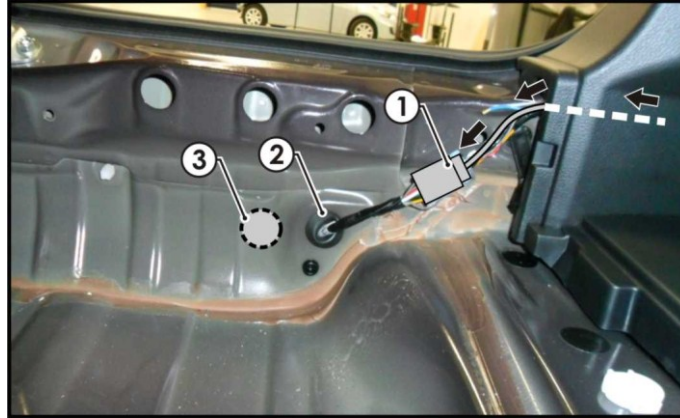

Note: If vehicle grommet is occupied as sunroof drainage, drill a Ø30mm hole (3) in the location shown.

10. Mount the trailer socket to the tow bar mounting bracket using M4 fasteners (not supplied).
11. Route the tail harness across the tow bar towards the RHS of the vehicle and up through the previously drilled out hole.
12. Ensure the tail harness grommet is seated correctly and secure in place using a cable tie (not supplied).
13. Connect the tail harness (tail length 1200mm) 8-way connector to the trailer patch mating 8-way connector.
14. Test the trailer wiring harness function using a light board or multi meter.
15. Secure all harnesses using cable ties (not supplied).
16. Re-fit all removed parts and secure all fasteners, ensuring there are no squeaks or rattles.
17. Place the fitting instructions in the glove box after fitment.

TRAILBOSS

Wiring Loom Fitting Instructions To Suit Subaru Liberty (Sedan & Wagon), Outback & Forester (2003 – Onwards), Subaru XV, Impreza (2007 – 2012), Impreza (2012 – Onwards) Part Number 100201-WL

The following steps are for Subaru Impreza (2007 – 2012) & Impreza (2012 – Onwards) models only. For Liberty Wagon & Outback models, refer to page 2. For Liberty Sedan models, refer to page 3. For Forester models, refer to page 4. For Subaru XV, refer to page 5.

1. Inside the luggage compartment, remove the floor carpet cover.
2. Remove the rear luggage compartment trim by first releasing the three fasteners.
3. On the LHS of the luggage compartment, remove the foam support cover.

The following steps 4 – 6 are for Subaru Impreza (2012 – Onwards) models only.

4. Remove the three clips and then remove the LHS luggage compartment trim.
5. To enable the RPA cutout, splice the loose GREY/WHITE wire from the tail harness to the PIN 1 (PURPLE wire) of the connector.
6. On the tail harness splice the GREY wire back into any ground wire of the harness.
7. On the RHS rear wheel well, remove the blanking grommet (1) and drill a Ø30mm hole.
8. File any rough or sharp edges and spray with rust inhibitor.

Note: If grommet is occupied drill a Ø30mm hole (2) next to the occupied grommet.

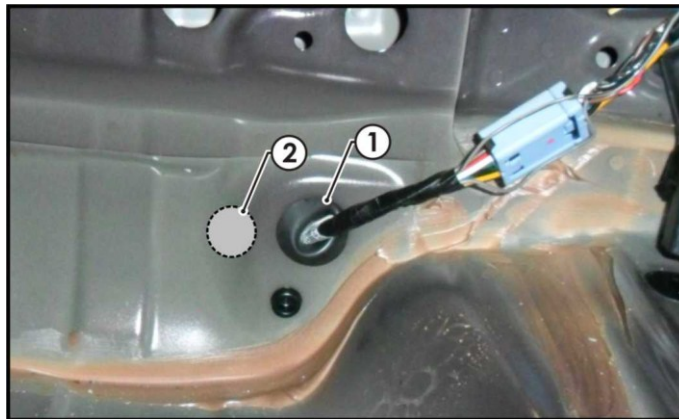

The following steps 9 – 11 are for Subaru Impreza (2007 – 2012) models only.

9. Locate the vehicle break out connector in the LHS rear quarter panel.
10. Connect the trailer patch (100201-WL) connector to the vehicle's break out connector.
11. Route the trailer patch towards the rear vehicle grommet.



Wiring Loom Fitting Instructions
To Suit Subaru Liberty (Sedan & Wagon), Outback & Forester
(2003 – Onwards), Subaru XV, Impreza (2007 – 2012),
Impreza (2012 – Onwards)
Part Number 100201-WL

The following steps 12 – 14 are for Subaru Impreza (2012 – Onwards) models only.

12. Locate the vehicle break out connector on the LHS rear quarter panel.
13. Connect the trailer patch (100201-WL) connector to the vehicle's break out connector.
14. Route the trailer patch towards the rear vehicle grommet.
15. Mount the trailer socket to the tow bar mounting bracket using M4 fasteners (not supplied).
16. Route the tail harness across the tow bar towards the LHS of the vehicle and up through the previously drilled out hole.
17. Ensure the tail harness grommet is seated correctly and secure in place using a cable tie (not supplied).
18. Connect the tail harness (tail length 1200mm) 8-way connector to the trailer wiring harness mating 8-way connector.
19. Test the trailer wiring harness function using a light board or multi meter.
20. Secure all harnesses using cable ties (not supplied).
21. Re-fit all removed parts and secure all fasteners, ensuring there are no squeaks or rattles.
22. Place the fitting instructions in the glove box after fitment.